

TAPERED SQUARE DOWNPIPE 100 x 75 Installation

Fixing Instructions

1. The downpipe big end is placed over the outlet in the gutter.
2. Multiple lengths if required are joined simply by sliding the small end into the large end until the downpipe is long enough to fit into the storm water drain outlet.
3. Clips or astrigals are then placed over the downpipe and fixed to the wall or post at spacing of no greater than 2 metres apart.

Making offsets

1. Measure the distance from the back of the gutter drop to the wall or post

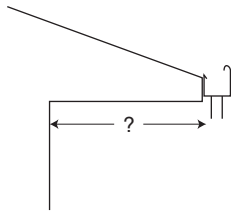

2. Lay downpipe with seam facing up and using the big end measure down approx 150cm and mark mitre cut. For 100 x 75 cut out 70mm + 65mm. For 100 x 50 cut out 45mm + 40mm.

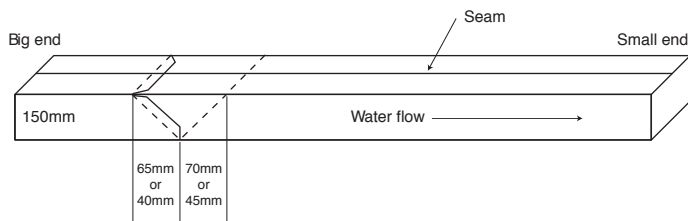

3. Leave 100mm tabs on flow side. Fold up to form angle, rivet and seal.

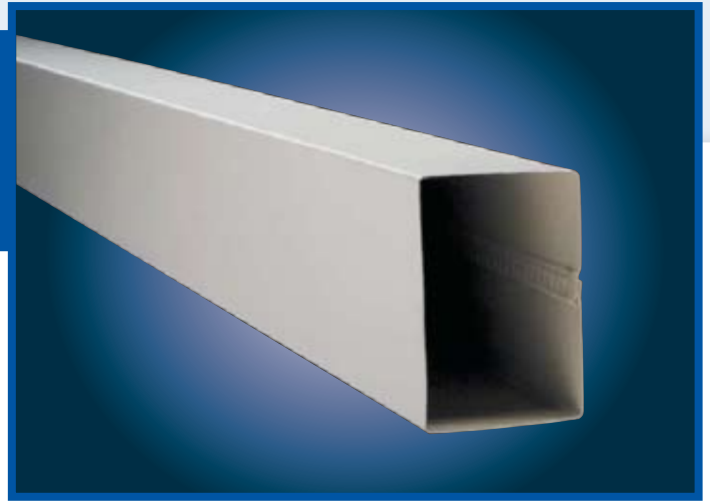
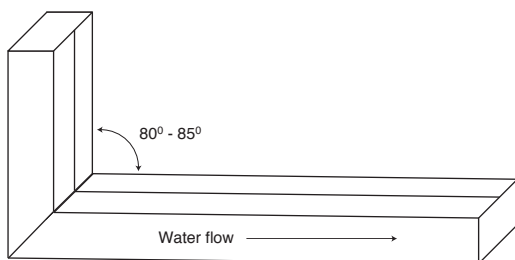

4. Lay straight edge as shown and mark the measurement from step 1 at right angle to the straight edge.

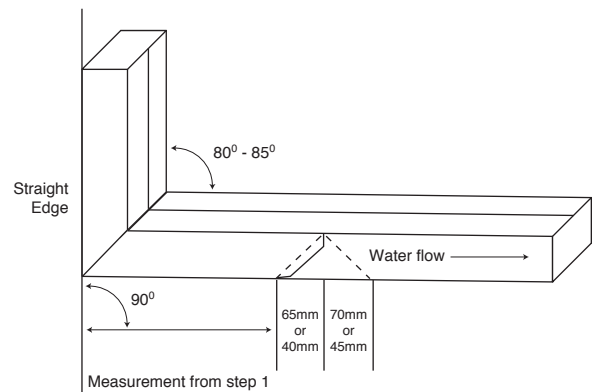

5. Mark and cut downpipe as shown in step 4.
6. Leave 10mm tabs on flow side and fold to form second angle, rivet and seal.

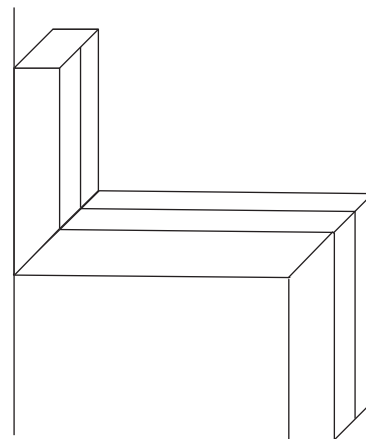

7. To extend downpipe to drainage level simply add extra lengths using the big and small end system.

